

OneFive ORIGAMI 03XP(-S)-2P

Dual wavelength UV femtosecond laser

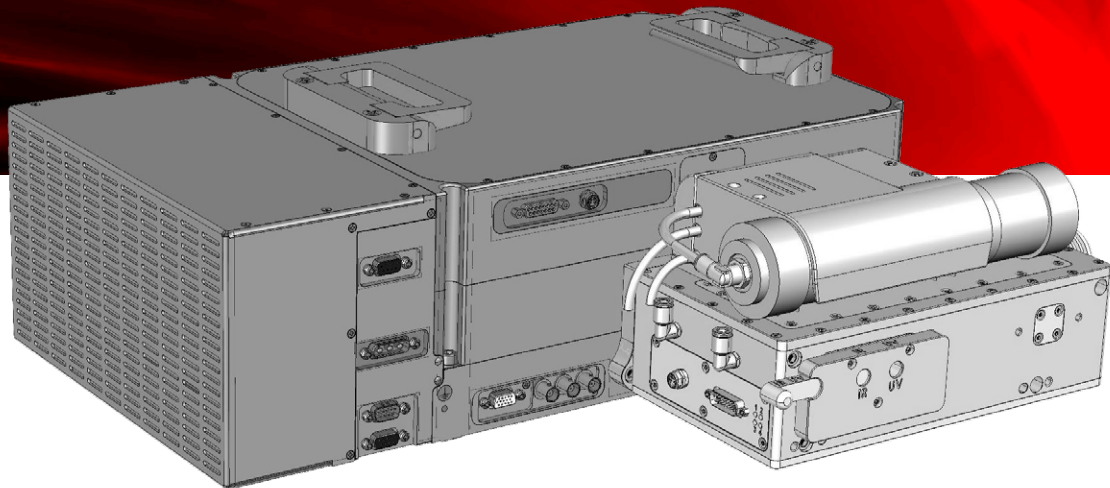

FEMTOSECOND IR AND UV

Dual wavelength flexibility

The ORIGAMI 03XP-2P and higher power 03XP-S-2P is a dual wavelength femtosecond laser, allowing computer-controlled, flexible switching between IR and UV wavelengths in one laser system.

Based on the highly successful ORIGAMI XP platform, the same advantages of clean, femtosecond pulse output, excellent beam quality together with unprecedented beam stability are obtained by virtue of the Optocage™ laser design.

Applications

- Foil cutting
- LCD patterning
- OLED display repair
- Flex PCB processing
- Medical device manufacturing

ONEFIVE ORIGAMI 03XP(-S)-2P

High reliability for industrial and medical applications

The ORIGAMI 03XP(-S)-2P has been designed with a focus on high reliability and unprecedented UV lifetime.

Easy availability of IR and UV wavelengths ensure the user can process a variety of materials with the Origami 03XP(-S)-2P.

The combination of multiple wavelengths together with clean femto-second pulse output allows efficient processing of materials where low HAZ is essential.

Features

- IR and UV selectable output
- > 10,000 hours reliability
- < 400 fs UV pulse duration
- Single-shot or Pulse-on-demand
- Excellent pointing stability
- Superior beam quality
- In-field replaceable purge system
- Air or water cooled
- Performance monitoring
- On-board diagnostics
- Ethernet communications

TYPICAL OUTPUT PULSE WIDTH

Typical clean output pulse traces from the 03XP-2P showing a close fit to ideal (Sech²).

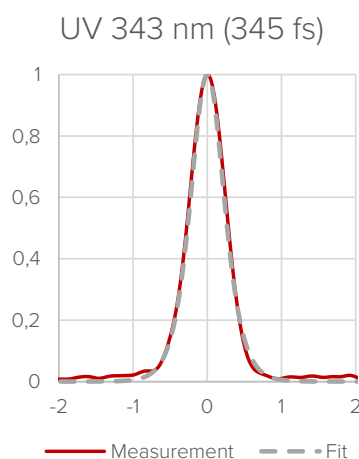
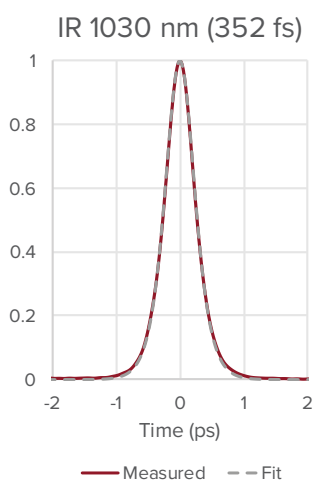

PERFORMANCE

Typical 03XP-2P IR performance

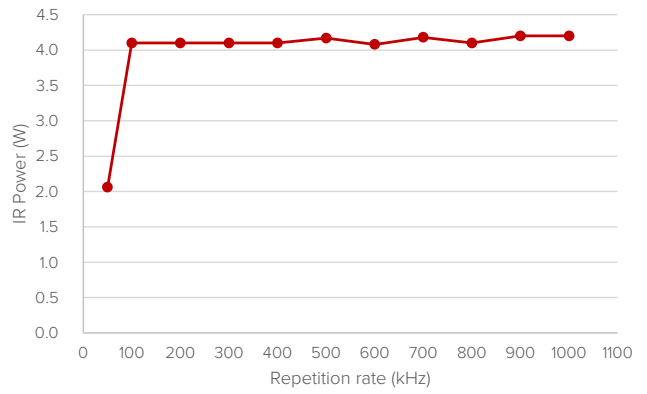
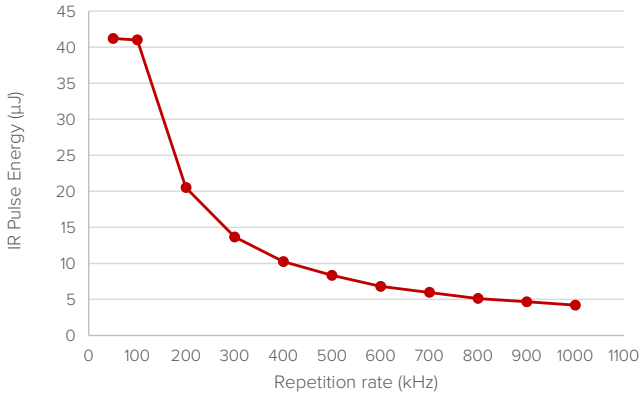

Typical 03XP-2P UV performance optimized for 100 kHz

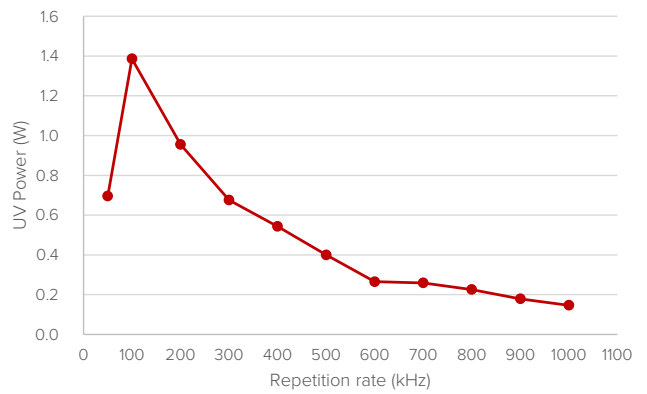
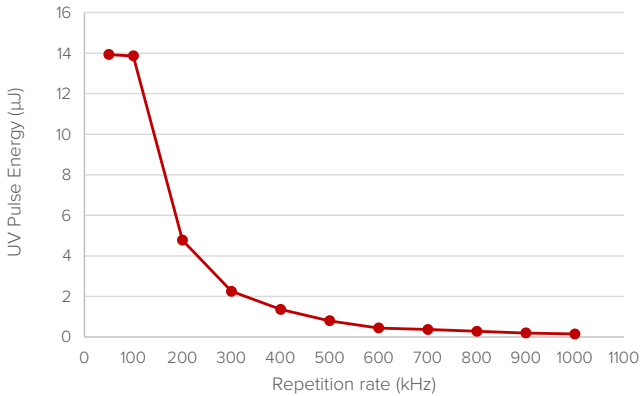

Typical 03XP-2P UV performance optimized for operation above 500 kHz

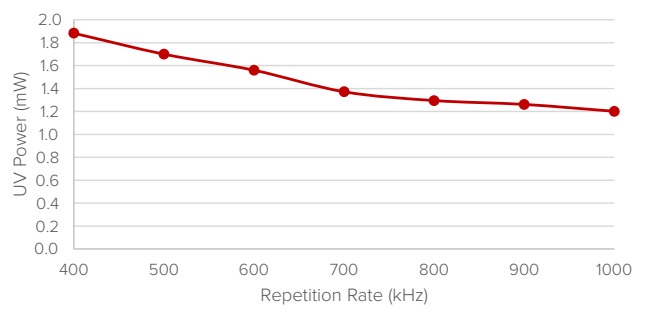
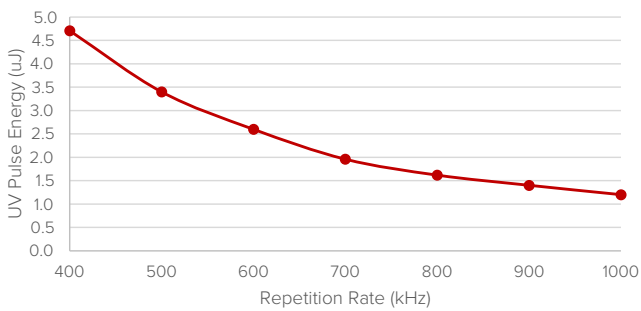

SPECIFICATIONS

Optical

Model	03XP	03XP-S
Center wavelength [nm]	343	343
Pulse duration [fs]	< 400	< 400
Average power [W]	> 1.2	> 1.5
Pulse energy [μ J]	12	20
Peak power [MW]	> 30	> 50
Spectral bandwidth [nm]	< 1	< 1
Pulse selection options	Single-shot to 1MHz. Pulse-on-demand	Single-shot to 1 MHz, Pulse-on-demand
Beam quality (TEM_{00})	$M^2 \leq 1.3$	$M^2 \leq 1.3$
Polarization / PER (vertical) [dB]	> 20	> 20
Beam diameter [mm]	2	2
Power stability (RMS, 12h, constant temp) [%]	< 2	< 2
Ellipticity	< 1.2	< 1.2
Pulse-to-pulse stability (RMS) [%]	< 2	< 2
Pointing stability	< 30 μ rad rms (12h), constant temp. < 15 μ rad / °C 18 – 28 °C	< 30 μ rad rms (12h), constant temperature < 15 μ rad / °C 18 – 28 °C

MECHANICAL DRAWINGS

Mechanical/Electrical

Laser output	Collimated free-space
Warm-up time [min.]	< 10 (warm start)
	< 30 (cold start)
Operation temperature [°C]	18 – 28
Storage temperature [°C]	-20 – 55
Power supply requirements	24 VDC/20A or 90-264 VAC, 47-63 Hz
Power consumption [W]	< 500
Laser head dimensions (WxHxD) [mm]	585.6 x 176 x 438.5
Power supply dimensions (WxHxD) [mm]	165 x 85 x 314
Laser head weight [kg]	33 kg (water-cooled)
	33 kg (air-cooled)
Cooling	Water or air

Support and warranty

All ORIGAMI products come with an industry-leading reliability.

The product is covered by a comprehensive warranty. Service options are available. For details, please enquire.

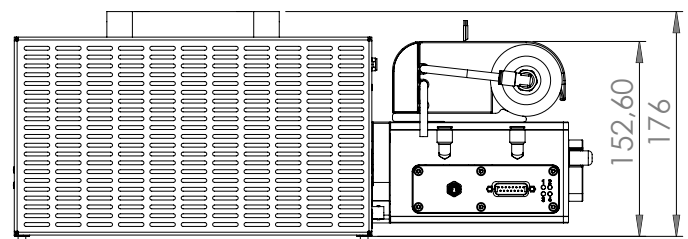
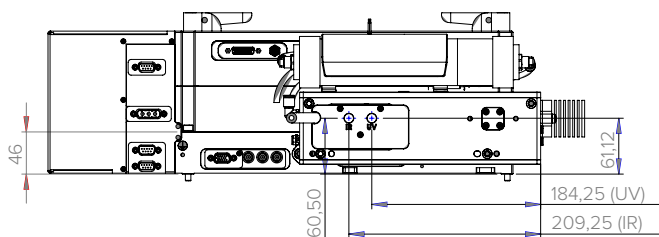
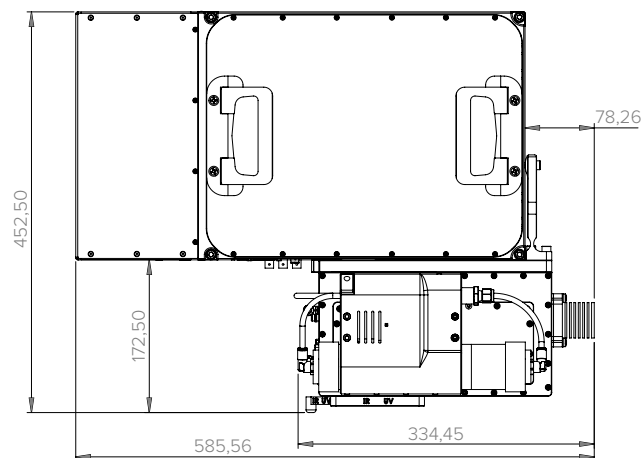

All ORIGAMI products are produced under our quality management system certified in accordance with the ISO 9001:2015 and ISO 13485:2016 standard.

