

APPLICATION NOTE

Coherent Anti-Stokes Raman Scattering Microspectrometer

36

Technology and Applications Center
Newport Corporation

Coherent Anti-Stokes Raman Scattering Microspectrometer

Introduction

Coherent Anti-Stokes Raman Scattering (CARS) was first reported in 1965 by Maker and Terhune¹ as a method of spectroscopy for chemical analysis. The energy diagram of the process is depicted in Figure 1. CARS involve the interaction of four waves designated as pump (p), Stokes (s), probe (p') and anti-Stokes (CARS) where pump and probe are usually fixed to the same frequency ($\omega_p = \omega_{p'}$). If the frequency difference between the pump and Stokes waves matches the vibrational transition Ω_R of the sample (i.e. $\Omega_R = \omega_p - \omega_s$), CARS provides chemical selectivity due to a resonant enhancement of the third-order nonlinear signal. Being a coherent spectroscopy, the information content of CARS is the same as that of Raman spectroscopy. The main difference is that CARS is a four-wave mixing process that generates a coherent collimated directional beam with several orders of magnitude higher intensity, where the wavelength is blue-shifted with respect to the pump and Stokes beams. Also in a noncollinear geometry under proper phase matching conditions, the CARS beam propagates in a different direction. All of these factors simplify detection of the CARS signal.

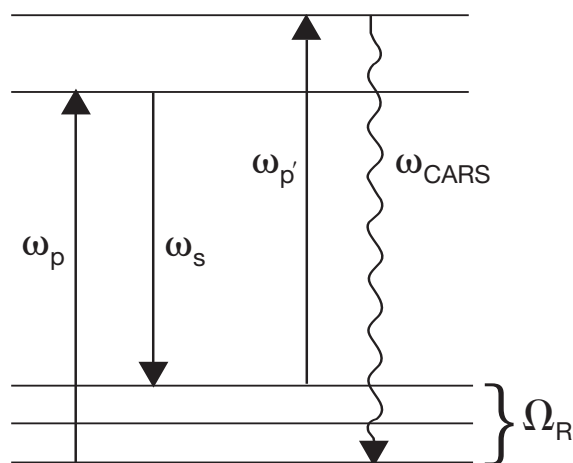

Figure 1. Energy diagram of the CARS process. The CARS signal is resonantly enhanced when the difference between the pump ω_p and Stokes ω_s frequencies matches a vibrational transition Ω_R of the molecule.

Utilizing the same beam for pump and probe, the intensity of the CARS signal can be written as

$$I_{CARS}(\Omega) \propto \left| \chi_{CARS}^{(3)}(\Omega) \right|^2 I_p^2 I_s \quad (1)$$

where I_p and I_s are the intensities of the pump/probe and Stokes beams, and $\chi^{(3)}$ is the third-order nonlinear susceptibility which depends on the material properties of the sample. By recording the dependence of the anti-Stokes signal on the frequency difference between the pump and Stokes beams, it is possible to obtain spectroscopic information about the vibrational transitions of molecules.

CARS as a method of microscopy was first reported in 1982², and later revisited by the Xie group in 1999.³ Being a nonlinear process, CARS allows image sectioning similar to two-photon excited fluorescence microscopy without the need for sample labeling. Significant efforts by several research groups were devoted to CARS imaging. The major challenges addressed were with regard to the laser sources and improvement of the technique. The results are summarized in several review articles.^{4, 5, 6, 7}

There are many variants of CARS spectroscopy. In this application note we will focus on the multiplex approach, which is also referred to as broadband CARS. Multiplex CARS, illustrated in Figure 2, was first proposed by Akhmanov et al.⁸

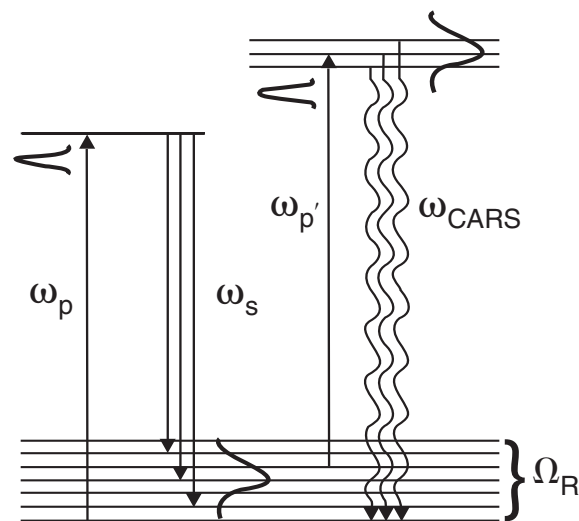

Figure 2. The combination of spectrally narrow picosecond pulse as a pump ω_p and probe $\omega_{p'}$ and a broadband femtosecond pulse as Stokes is the basis for broadband CARS.

The pump pulse has a narrow bandwidth and defines the spectral resolution in the CARS spectrum. The Stokes pulse is spectrally broad, usually in the femtosecond regime. Application of the pump and Stokes pulses excites multiple Raman transitions within the bandwidth of the Stokes pulse. Vibrationally excited states are probed with a third spectrally narrow probe pulse, usually the same as the pump pulse. The information is transferred into the anti-Stokes signal spectrum through the virtual states. In a single shot the entire CARS spectrum of the excited states is generated.

The broadband CARS method was successfully applied in spectroscopy and microscopy using different combinations of narrow and broadband collinearly propagating laser beams.⁴ The choice of lasers depends on the specific application. In general, it is desirable to have a Stokes beam with a spectrum as broad as possible. The important fingerprint region of Stokes shifts in biological samples is in the range of 500-4000 cm^{-1} . This defines the requirements for the broadband light source for multiplex CARS. Generation of laser pulses with 4000 cm^{-1} bandwidth, which corresponds to a few femtosecond pulse duration, present significant challenges. An alternative method is to use a supercontinuum source. Recent advances in the development of Photonic Crystal Fibers (PCF) made them a reliable source of supercontinuum (SC) when injected with just a

few tens of mW of average power from the output of a femtosecond oscillator. Supercontinuum has previously been demonstrated as a potential source for broadband multiplex CARS.⁹

The CARS microspectrometer setup described in this application note is based on the broadband approach. It utilizes Newport's PCF supercontinuum kit described in detail in Application Note 28 (http://www.newport.com/file_store/Optics_and_Mechanics/AppsNote28.pdf).

Experimental setup

WARNING!! - Visible and invisible radiation emitted by laser devices can be dangerous to the eyes and appropriate precautions must be taken when lasers are in use. Only individuals who are adequately trained in proper laser use and safety procedures should operate the laser devices described herein. The Glan-laser Polarizers used in this application have side ports where the rejected portions of the laser beams exit. As the polarizers are rotated about the primary beam axes, the exit angles of these beams will change accordingly. Always maintain proper safeguards to block these beams and prevent potential injury.

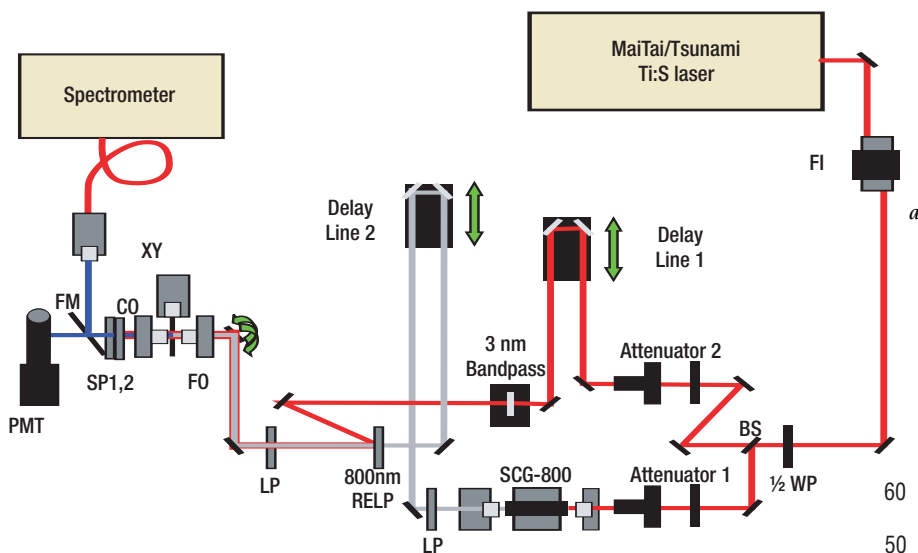
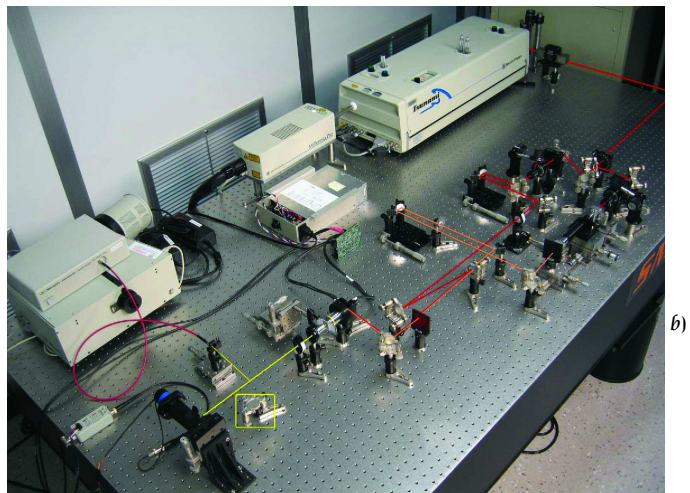

Figure 3. Block diagram (a) and photograph (b) of the experimental setup.

FI – Faraday isolator, 1/2 WP – half wave plate, BS – beam splitter, RELP – razor edge long pass filter, LP – long pass filter, SCG-800 – supercontinuum generation kit, FO – focusing objective, CO – collimating objective, SP – combination of short pass filters, FM – flip mount, PMT – photomultiplier.

The block diagram and the actual experimental setup are shown in Figure 3a and 3b.

It is based on Spectra-Physics Tsunami® or MaiTai® Ti:Sapphire femtosecond oscillator and Newport's supercontinuum generation kit. The laser is isolated from the rest of the setup by means of a Faraday isolator (FI). The Faraday isolator is not an optional component and is required in this setup to prevent multiple back reflections from reaching the oscillator. The laser output is divided into two arms to form the pump and Stokes beams. We used a 50/50 ultrafast beam splitter, which is designed for S-polarization (see Figure 4).

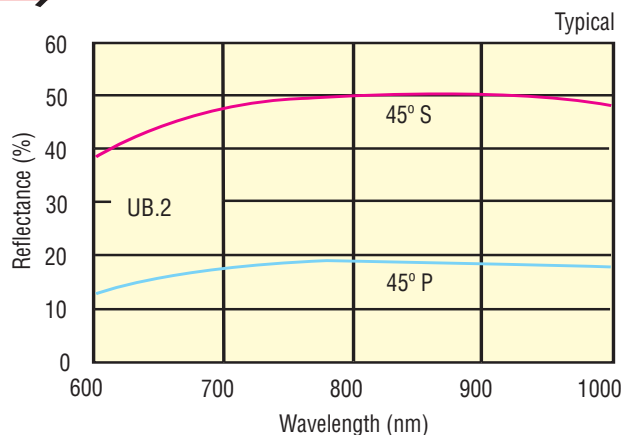

Figure 4. Reflectance of the ultrafast beamsplitter for S and P-polarizations.

Rotation of the input polarization with a 1/2 wave-plate continuously varies the splitting ratio between 20% and 50%. Each arm of the setup has a variable attenuator (www.newport.com/file_store/Optics_and_Mechanics/AppsNote26.pdf), which allows independent control of intensity

and polarization. About 20% of the 2.5W output power at 800nm is directed to the supercontinuum generation module illustrated in Figure 5.

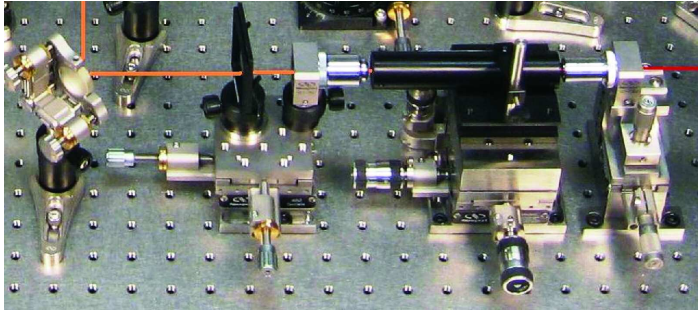

Figure 5. Supercontinuum module

The setup and alignment procedure of the SC module is described in Application Note 28. A long pass filter LP (RG750) after the collimating objective, selects out the long wavelengths of the supercontinuum to form the Stokes beam. The collimated beam passes through Delay Line 2, additional routing mirrors and a 808 nm Razor Edge Long Pass filter (REL P) with a transition width of 125 cm^{-1} (LP02-808RU-25 Semrock®). Figure 6 illustrates the delay line assemblies for both beams.

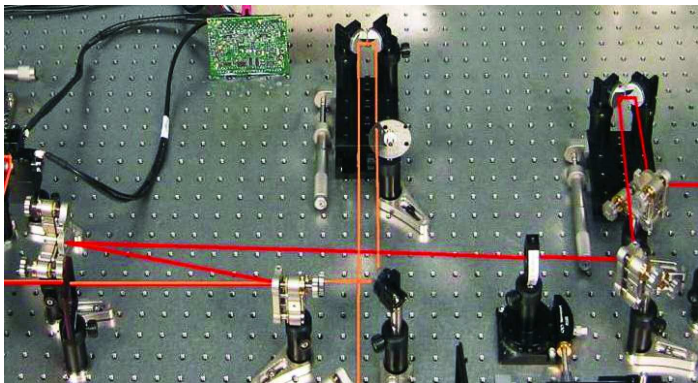

Figure 6. Delay lines for the pump and Stokes beams.

A second long pass filter LP (RG 750,) provides additional filtering of the visible light. The Stokes beam is then routed into the back aperture of the focusing objective FO and is focused into the sample (Figure 3a).

The remaining 80% of the 800 nm beam passes through Attenuator 2 and is directed to Delay Line 1. The band pass filter BP (LL01-808-25, Semrock) narrows the spectrum of the 800 nm beam down to 3 nm to form the pump beam. The filter is mounted on a rotation stage, and the angle of incidence is adjusted to shift the center of the band to 800 nm. The pump beam recombines with the Stokes beam after reflecting from a 810 nm REL P long pass filter (LP02-808RU-25, Semrock). At this point it is important to verify that the beams propagate on top of each other. First make sure both beams are overlapped on the REL P filter by adjusting the 800 nm pump beam with the routing mirror just before the filter. Let the beams propagate at least a few meters

and overlap them in the far field by adjusting the REL P filter. After careful alignment, the pump and Stokes beams are routed to the back aperture of the focusing objective FO. The sample is attached to an XYZ stage for accurate positioning. For imaging purposes a motorized XYZ stage can be used.⁹ Alternatively, the routing mirror before the focusing objective FO can be replaced with an XY galvo scanner. The microscope objective CO behind the sample, collimates the anti-Stokes beam. The combination of a Razor Edge short pass filter SP1 (Semrock SP01-785RU) and SP2 (Edmund Optics® NT 47-588) positioned after the sample, transmits wavelengths shorter than 780 nm. The flip mirror mount FM is used to direct the collimated anti-Stokes beam into a spectrometer or photomultiplier (PMT).

The most challenging part of the setup is correct timing between the pump and Stokes pulses, as they need to overlap in time and space. The first step is to measure the optical path lengths for both beams as accurately as possible and then set up the delay lines in a way such that the two path lengths are equal and that the translation stages are approximately in their center of translation range. In principle, only one delay line is necessary to achieve equal optical path lengths; however, finding the zero delay point is more convenient using two delay lines. By simply translating each stage by hand, one can readily cover both positive and negative delays.

The second step is finding the zero delay point. What follows are two convenient methods. The first is simply finding the CARS signal from a 1 mm thick glass microscope slide. Take care to ensure that the beams are focused inside the slide. Utilize the maximum available power in the pump and Stokes beams. Use a 100 mm focal length lens (not shown in Figure 3) after the FM mount to focus the CARS signal beam into the fiber spectrometer. Alternatively, the collimating objective CO can be positioned to focus the CARS beam on the input of the fiber coupled spectrometer. Let some of the visible light leak through and align the fiber. Monitor the CARS signal on the spectrometer and slowly vary the delay on each of the delay lines. When passing the zero delay position you will notice a spectrally broad spike in the CARS signal on the spectrometer within the spectral range between 600 nm and 780 nm. Adjust the micrometers on the stages to accurately position them at zero delay. Maximize the signal by adjusting the spatial overlap of the beams by adjusting the REL P filter and then by adjusting the collimation of the supercontinuum. This should be done iteratively while optimizing the zero delay point after every step.

The second method is based on the generation of the sum frequency signal in a nonlinear crystal (not included with the kit). In this case, the polarizations of both beams should be set to vertical. The sample is replaced with a 1 mm BBO crystal cut for Type I second harmonic generation (SHG) at 800 nm. A diffraction grating is placed after the collimating objective CO behind the sample. By rotating the crystal one can see the SH of 800 nm and a broad green color from the SH of the SC. Find the crystal angle where both SH spots are visible (they will both be weak). Start varying the delays. At

the zero delay point, you will see a flash of blue/violet light positioned between the two SH spots. Optimize the sum frequency signal by adjusting the delay, spatial overlap and collimation as described for the first method above.

Results

Using the setup described in this note we recorded CARS spectra of several samples. All samples were placed on a microscope slide with or without a cover slip on top. Figure 7 shows the CARS signal generated from a microscope slide only.

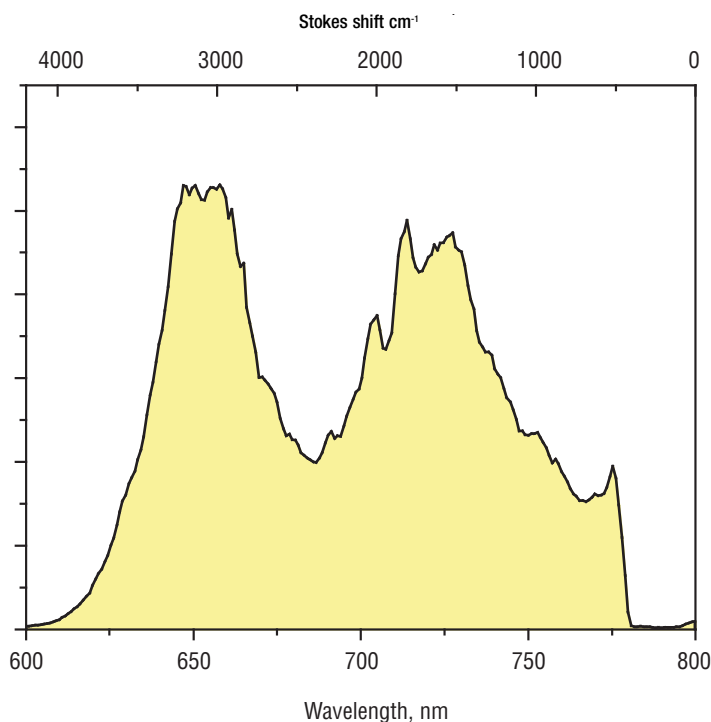

Figure 7. CARS signal from a microscope slide. Features in the signal correspond to the structure of the supercontinuum. The observable Stokes shifts range from 200cm^{-1} to 4000cm^{-1} .

The origin of the signal is purely electronic and non-resonant. The fine structure in the signal corresponds to the spectral features of the supercontinuum. It depends on the time delay between the Stokes and pump pulses due to the group delay dispersion (GDD) present in both beams as well as the pulse width and power of the beam used to generate supercontinuum. The spectral region of interest, where the most informative CARS signal is located, can be enhanced by adjusting the timing between the pump and Stokes pulses and the power of the beam used to generate the supercontinuum. For example, if we are interested in recording the CARS signal corresponding to a C-H stretch around 2900cm^{-1} , we can adjust the delay between pump and Stokes beam as well as the pump power for the supercontinuum in a manner such that the amplitude of the signal around 650nm is enhanced at the expense of decreasing the amplitude at longer wavelengths. If the CARS

signal is broader than the spectral features shown in Figure 7, then it should be normalized by dividing the signal by the spectral density of the supercontinuum as shown in Figure 7.

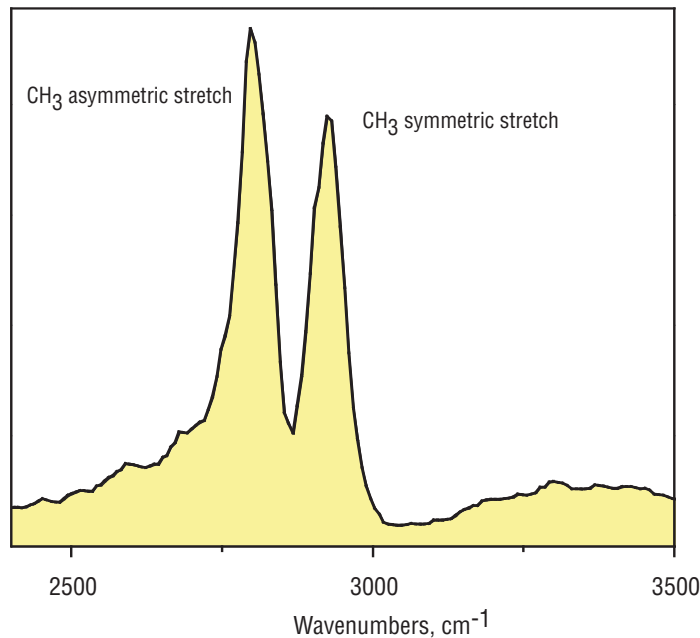

Figure 8. CARS spectrum of methanol. Symmetric and asymmetric CH_3 stretching modes are clearly resolved.

The CARS spectrum of methanol is shown in Figure 8. Two stretching modes are clearly resolved. The separation between the two peaks is 110cm^{-1} . The expected spectral resolution defined by the spectrum of the pump pulse is about 50cm^{-1} . For most CARS imaging applications, this should be enough to resolve contributions from different vibrational modes.

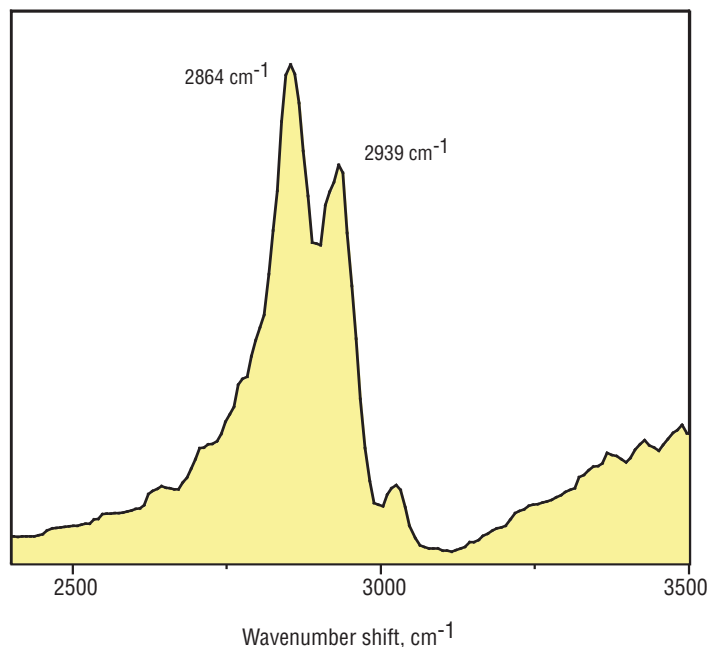

Figure 9. CARS spectrum of PMMA. CH_3 stretching modes separated by 75cm^{-1} are resolved.

As another demonstration of this setup's capabilities, the spectrum of the Acrylic resin PMMA is illustrated in Figure 9. In this sample, two stretching modes of CH₃ are less resolved due to the fact that the peaks are only separated by 75cm⁻¹.

Acetone is exhibiting only a single peak in its CARS spectrum, as shown in Figure 10.

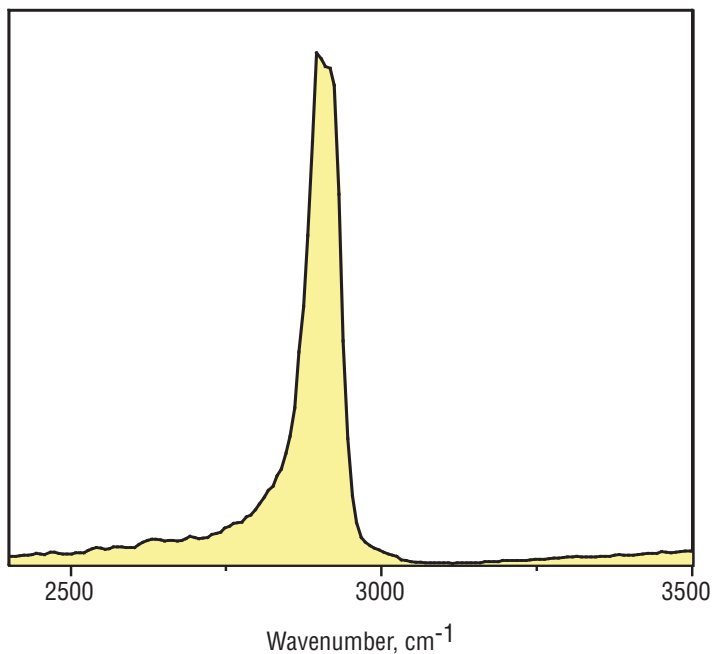

Figure 10. CARS spectrum of acetone. A single peak is observed.

The experimental setup described in this note can also be used for imaging by simply replacing the turning mirror before the focusing objective FO with an XY galvo scanning system or by placing the sample on a computer controlled XYZ stage, similar to the setup used by Kano et al.⁹ In this case the flip mount should be switched to the PMT. As an example, Figure 11 shows the image of 10 μm polystyrene beads. The corresponding CARS spectrum is shown in Figure 12. We used a 650 nm bandpass filter and acquired only the signal corresponding to the CH stretching mode of polystyrene (shaded area on the graph).

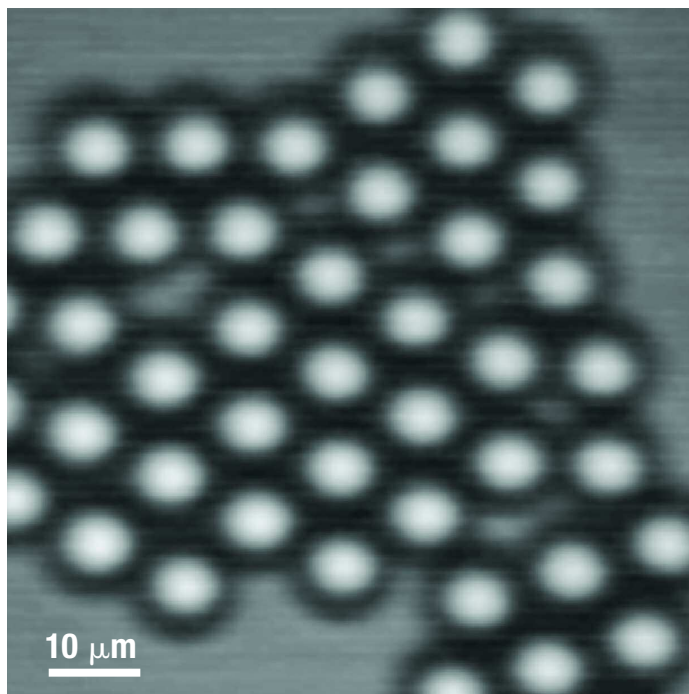

Figure 11. CARS image of 10 μm polystyrene beads.

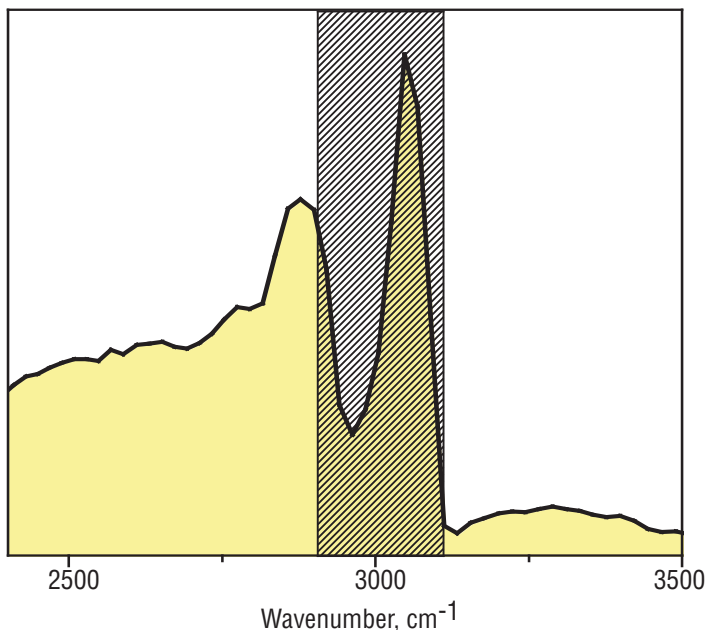

Figure 12. CARS spectrum of polystyrene beads. The shaded area represents the transmission window of the bandpass filter in front of the PMT.

As a more real-world application, we have imaged rat uterus tissue at CH stretching resonance. The results can be seen in Figure 13. This image was acquired using an XY galvo scanning system and a 650 nm bandpass filter with the same scan and zoom parameters used to acquire the image shown in Figure 11. As an example of a non-biological application, we recorded CARS images of a nanostructure fabricated by two-photon polymerization of a PMMA resin. The results are shown in Figure 14.

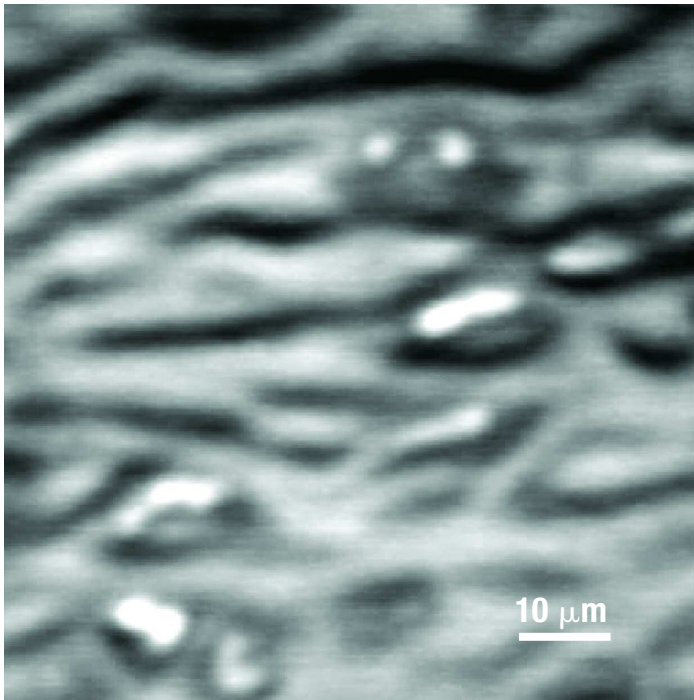

Figure 13. CARS image of rat uterus tissue.

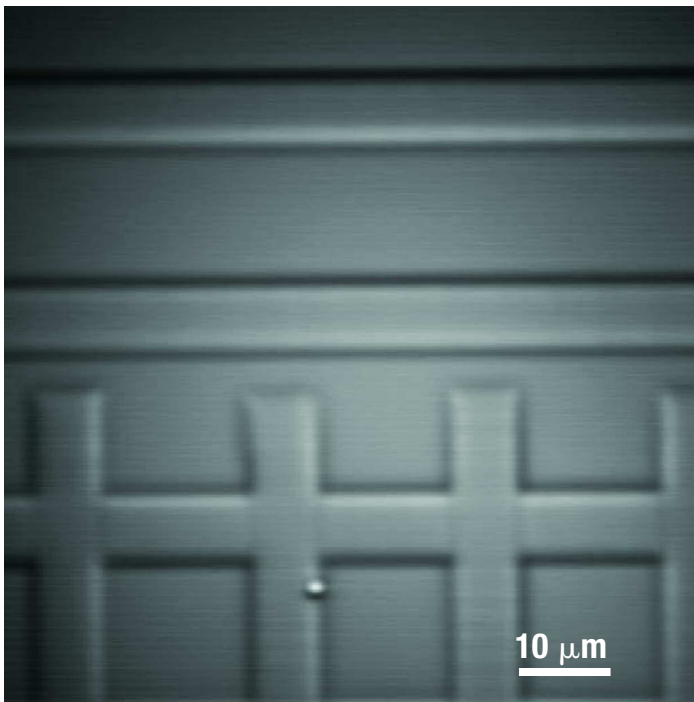

Figure 14. CARS image of a model structure fabricated by two-photon polymerization of PMMA resin. The scale is similar to that in fig. 11 and 13.

In conclusion, we described a simple, cost effective device for CARS microspectroscopy that can be readily built using standard off-the-shelf parts. It can easily be modified for various applications.

References

1. P. D. Maker and R. W. Terhune, Phys. Rev. (1965) **137**, A801.
2. M. D. Duncan, J. Reintjes and T. Manuccia, J. Opt. Lett. (1982) **7**, 350.
3. A. Zumbusch, G. R. Holtom and X. S. Xie, Phys. Rev. Lett. (1999) **82**, 4142
4. J. X. Cheng and X. S. Xie, J. Phys. Chem. (2004) **108**, 827
5. A. Volkmer, J. Phys. D. (2005) Appl. Phys. **38**, R59.
6. J. X. Cheng, J. Applied Spectroscopy (2007) **61**, 197a
7. M. Mueller and A. Zumbusch, ChemPhysChem (2007) **8**, 2156.
8. S. A. Akhmanov, N. I. Koroteev and A. I. Kholodnykh, J. Raman Spectroscopy (1974) **2**, 239.
9. H. Kano and H. Hamaguchi, Appl. Phys. Lett. (2005) **86**, 121113

Newport Corporation

Worldwide Headquarters

1791 Deere Avenue
Irvine, CA 92606

(In U.S.): 800-222-6440

Tel: 949-863-3144

Fax: 949-253-1680

Email: sales@newport.com



Newport

Experience | Solutions



Visit Newport Online at: www.newport.com

This Application Note has been prepared based on development activities and experiments conducted in Newport's Technology and Applications Center and the results associated therewith. Actual results may vary based on laboratory environment and setup conditions, the type and condition of actual components and instruments used and user skills.

Nothing contained in this Application Note shall constitute any representation or warranty by Newport, express or implied, regarding the information contained herein or the products or software described herein. Any and all representations, warranties and obligations of Newport with respect to its products and software shall be as set forth in Newport's terms and conditions of sale in effect at the time of sale or license of such products or software. Newport shall not be liable for any costs, damages and expenses whatsoever (including, without limitation, incidental, special and consequential damages) resulting from any use of or reliance on the information contained herein, whether based on warranty, contract, tort or any other legal theory, and whether or not Newport has been advised of the possibility of such damages.

Newport does not guarantee the availability of any products or software and reserves the right to discontinue or modify its products and software at any time. Users of the products or software described herein should refer to the User's Manual and other documentation accompanying such products or software at the time of sale or license for more detailed information regarding the handling, operation and use of such products or software, including but not limited to important safety precautions.

This Application Note shall not be copied, reproduced, distributed or published, in whole or in part, without the prior written consent of Newport Corporation.

Copyright ©2007 Newport Corporation. All Rights Reserved. Mai Tai®, Tsunami®, Spectra-Physics®, the Spectra-Physics "S" logo, and the Newport "N" logo, are registered trademarks of Newport Corporation. Newport™, is a trademark of Newport Corporation. Semrock® is a registered trademark of Semrock, Inc. Edmund Optics® is a registered trademark of Edmund Optics, Inc.



Newport Corporation, Irvine, California, has been certified compliant with ISO 9001 by the British Standards Institution.

MM#9000096
DS-12065