

Product Specification

RoHS-6 Compliant

10Gb/s 10km Single Mode Bidirectional SFP+ Transceiver

FTLX2072D327/FTLX2072D333

PRODUCT FEATURES

- Hot-pluggable SFP+ footprint
- Bidirectional 10G over single strand single mode fiber
- Supports 1.0 to 11.3Gb/s bit rates
- Power dissipation <1W
- RoHS-6 compliant (lead-free)
- Industrial temperature range -40°C to 85°C
- Single 3.3V power supply
- Maximum link length of 10km
- Uncooled DFB
- Receiver limiting electrical interface
- Single LC connector
- Built-in digital diagnostic functions



APPLICATIONS

- 10GBASE-LR/LW 10G Ethernet
- 1000BASE-LX10 Gigabit Ethernet
- 1200-SM-LL-L 10G Fibre Channel
- 2.457 Gb/s CPRI
- 3.072 Gb/s CPRI/LTE
- 4.915 Gb/s CPRI/LTE
- 6.144 Gb/s CPRI/OBSAI/LTE
- 9.8304 Gb/s CPRI/L

Finisar’s FTLX2072D327/FTLX2072D333 10Gb/s Enhanced Small Form Factor Pluggable SFP+ transceivers are designed for use in 10-Gigabit Ethernet links up to 10km over a single-strand Single Mode fiber. This capability doubles the capacity of installed legacy single mode fiber links. They are compliant with SFF-8431¹ and IEEE 802.3ae 10GBASE-LR/LW³, and 10G Fibre Channel 1200-SM-LL-L⁴. Digital diagnostics functions are available via a 2-wire serial interface, as specified in SFF-8472⁵. The FTLX2072D327/FTLX2072D333 is a “limiting module”, i.e., it employs a limiting receiver. Host board designers using an EDC PHY IC should follow the IC manufacturer’s recommended settings for interoperating the host-board EDC PHY with a limiting receiver SFP+ module. The optical transceiver is compliant per the RoHS Directive 2011/65/EU⁶. See Finisar Application Note AN-2038 for more details⁷.

PRODUCT SELECTION

Part Number	Wavelength
FTLX2072D327	1271 nm
FTLX2072D333	1331 nm

I. Pin Descriptions

Pin	Symbol	Name/Description	Ref.
1	V _{EET}	Transmitter Ground	1
2	T _{FAULT}	Transmitter Fault	2
3	T _{DIS}	Transmitter Disable. Laser output disabled on high or open.	3
4	SDA	2-wire Serial Interface Data Line	2
5	SCL	2-wire Serial Interface Clock Line	2
6	MOD_ABS	Module Absent. Grounded within the module	2
7	RS0	Rate Select 0. NC	4
8	RX_LOS	Loss of Signal indication. Logic 0 indicates normal operation.	5
9	RS1	Rate Select 1. NC	4
10	V _{EER}	Receiver Ground	1
11	V _{EER}	Receiver Ground	1
12	RD-	Receiver Inverted DATA out. AC Coupled.	
13	RD+	Receiver Non-inverted DATA out. AC Coupled.	
14	V _{EER}	Receiver Ground	1
15	V _{CCR}	Receiver Power Supply	
16	V _{CCT}	Transmitter Power Supply	
17	V _{EET}	Transmitter Ground	1
18	TD+	Transmitter Non-Inverted DATA in. AC Coupled.	
19	TD-	Transmitter Inverted DATA in. AC Coupled.	
20	V _{EET}	Transmitter Ground	1

Notes:

1. Circuit ground is internally isolated from chassis ground.
2. T_{FAULT} is an open collector/drain output, which should be pulled up with a 4.7k – 10k Ohms resistor on the host board if intended for use. Pull up voltage should be between 2.0V to V_{cc} + 0.3V. A high output indicates a transmitter fault caused by either the TX bias current or the TX output power exceeding the preset alarm thresholds. A low output indicates normal operation. In the low state, the output is pulled to <0.8V.
3. Laser output disabled on T_{DIS} >2.0V or open, enabled on T_{DIS} <0.8V.
4. Internally pulled down per SFF-8431 Rev 4.1.
5. LOS is open collector output. Should be pulled up with 4.7k – 10kΩ on host board to a voltage between 2.0V and 3.6V. Logic 0 indicates normal operation; logic 1 indicates loss of signal.

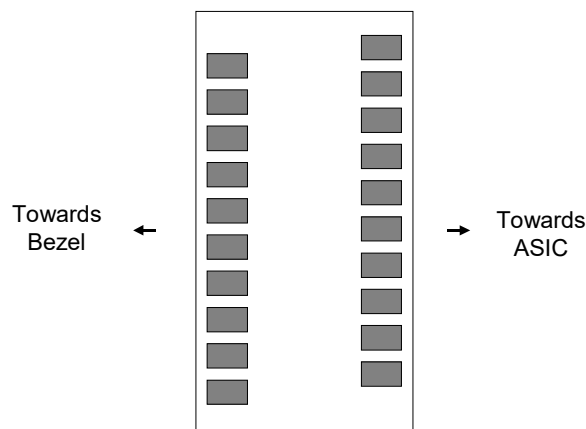

Figure 1. Diagram of Host Board Connector Block Pin Numbers and Names.

II. Absolute Maximum Ratings

Exceeding the limits below may damage the transceiver module permanently.

Parameter	Symbol	Min	Typ	Max	Unit	Ref.
Maximum Supply Voltage	V _{CC}	-0.5		4.0	V	
Storage Temperature	T _S	-40		85	°C	
Relative Humidity	RH	0		85	%	1

1. Non-condensing.

III. Electrical Characteristics (T_{OP} = -40 to 85 °C, V_{CC} = 3.14 to 3.46 Volts)

Parameter	Symbol	Min	Typ	Max	Unit	Ref.
Supply Voltage	V _{CC}	3.14	3.30	3.46	V	
Supply Current	I _{CC}		200	285	mA	
Transmitter						
Input differential impedance	R _{in}		100		Ω	1
Differential data input swing	V _{in,pp}	180		700	mV	
Transmit Disable Voltage	V _D	2		V _{CC}	V	
Transmit Enable Voltage	V _{EN}	V _{EE}		V _{EE} + 0.8	V	
Receiver						
Differential data output swing	V _{out,pp}	300		850	mV	2,6
Output rise time and fall time	T _r , T _f	28			ps	3
LOS Fault	V _{LOS fault}	2		V _{CC} HOST	V	4
LOS Normal	V _{LOS norm}	V _{EE}		V _{EE} +0.8	V	4
Power Supply Noise Tolerance	V _{CC} T/V _{CC} R	Per SFF-8431 Rev 4.1			mVpp	5

Notes:

1. Connected directly to TX data input pins. AC coupling from pins into laser driver IC.
2. Into 100Ω differential termination.
3. 20 – 80%. Measured with Module Compliance Test Board and OMA test pattern. Use of four 1's and four 0's sequence in the PRBS 9 is an acceptable alternative. SFF-8431 Rev 4.1.
4. LOS is an open collector output. Should be pulled up with 4.7kΩ – 10kΩ on the host board. Normal operation is logic 0; loss of signal is logic 1.
5. See Section 2.8.3 of SFF-8431 Rev 4.1.
6. The FTLX2072D327/FTLX2072D333 is a “limiting module”, i.e., it employs a limiting receiver. Host board designers using an EDC PHY IC should follow the IC manufacturer's recommended settings for interoperating the host-board EDC PHY with a limiting receiver SFP+ module.

IV. Optical Characteristics (T_{OP} = -40 to 85 °C, V_{CC3} = 3.14 to 3.46 Volts)

Parameter	Symbol	Min	Typ	Max	Unit	Ref.	
Transmitter							
Optical Modulation Amplitude (OMA)	P _{OMA}	-5.2			dBm		
Average Launch Power	P _{AVE}	-8.2		+0.5	dBm	1	
Optical Wavelength (FTLX2072D327)	λ	1260	1271	1280	nm		
Optical Wavelength (FTLX2072D333)	λ	1320	1331	1340	nm		
Side-Mode Suppression Ratio	SMSR	30			dB		
Optical Extinction Ratio	ER	3.5			dB		
Transmitter and Dispersion Penalty	TDP			3.2	dB		
Average Launch power of OFF transmitter	P _{OFF}			-30	dBm		
Tx Jitter	T _{Xj}	Per 802.3ae requirements					
Relative Intensity Noise	RIN			-128	dB/Hz		

Receiver						
Receiver Sensitivity (OMA) @ 10.3Gb/s	R _{SENS1}			-12.6	dBm	2
Stressed Receiver Sensitivity (OMA) @ 10.3Gb/s	R _{SENS2}			-10.3	dBm	3
Average Receive Power	P _{AVE}	-14.4		+0.5	dBm	4
Optical Wavelength (FTLX2072D327)	λ _R	1320		1340	nm	
Optical Wavelength (FTLX2072D333)	λ _R	1260		1280		
Optical Crosstalk				-40	dB	
External Isolation		30			dB	
Receiver Reflectance	R _{TX}			-12	dB	
LOS De-Assert	LOS _D			-17	dBm	
LOS Assert	LOS _A	-30			dBm	
LOS Hysteresis		0.5		6	dB	

Notes:

1. Average power figures are informative only, per IEEE 802.3ae.
2. Valid between stated wavelength range. Measured with worst case ER; BER < 10⁻¹²; 2³¹ - 1 PRBS.
3. Valid between stated wavelength range.
4. Average receive power (min) is informative and not the principal indicator of signal strength. A received power below this value cannot be compliant; however, a value above this does not ensure compliance.

V. General Specifications

Parameter	Symbol	Min	Typ	Max	Units	Ref.
Bit Rate	BR	1.0		11.3	Gb/s	1
Bit Error Ratio	BER			10 ⁻¹²		2
Max. Supported Link Length	L _{MAX}		10		km	1

Notes:

1. 100BASE-LX10, 10GBASE-LR, 10GBASE-LW, 1200-SM-LL-L 10GFC.
2. Tested with a 2³¹ - 1 PRBS.

VI. Environmental Specifications

Finisar FTLX2072D327/FTLX2072D333 transceivers have an operating temperature range from -40°C to +85°C case temperature.

Parameter	Symbol	Min	Typ	Max	Units	Ref.
Case Operating Temperature	T _{op}	-40		85	°C	
Storage Temperature	T _{sto}	-40		85	°C	

VII. Regulatory Compliance

Finisar transceivers are Class 1 Laser Products and comply with US FDA regulations. These products are certified by TÜV and CSA to meet the Class 1 eye safety requirements of EN (IEC) 60825 and the electrical safety requirements of EN (IEC) 60950. Copies of certificates are available at Finisar Corporation upon request.

VIII. Digital Diagnostic Functions

Finisar FTLX2072D327/FTLX2072D333 SFP+ transceivers support the 2-wire serial communication protocol as defined in the SFP MSA¹. It is very closely related to the E²PROM defined in the GBIC standard, with the same electrical specifications.

The standard SFP serial ID provides access to identification information that describes the transceiver's capabilities, standard interfaces, manufacturer, and other information.

Additionally, Finisar SFP+ transceivers provide an enhanced digital diagnostic monitoring interface, which allows real-time access to device operating parameters such as transceiver temperature, laser bias current, transmitted optical power, received optical power and transceiver supply voltage. It also defines a sophisticated system of alarm and warning flags, which alerts end-users when particular operating parameters are outside of a factory set normal range.

The SFP MSA defines a 256-byte memory map in E²PROM that is accessible over a 2-wire serial interface at the 8 bit address 1010000X (A0h). The digital diagnostic monitoring interface makes use of the 8 bit address 1010001X (A2h), so the originally defined serial ID memory map remains unchanged. The interface is identical to, and is thus fully backward compatible with both the GBIC Specification and the SFP Multi Source Agreement. The complete interface is described in Finisar Application Note AN-2030: "Digital Diagnostics Monitoring Interface for SFP Optical Transceivers".

The operating and diagnostics information is monitored and reported by a Digital Diagnostics Transceiver Controller (DDTC) inside the transceiver, which is accessed through a 2-wire serial interface. When the serial protocol is activated, the serial clock signal (SCL, Mod Def 1) is generated by the host. The positive edge clocks data into the SFP transceiver into those segments of the E²PROM that are not write-protected. The negative edge clocks data from the SFP transceiver. The serial data signal (SDA, Mod Def 2) is bi-directional for serial data transfer. The host uses SDA in conjunction with SCL to mark the start and end of serial protocol activation. The memories are organized as a series of 8-bit data words that can be addressed individually or sequentially.

For more information, please see the SFP MSA documentation^{1,5} and Finisar Application Note AN-2030.

Please note that evaluation board FDB-1027 is available with Finisar ModDEMO software that allows simple-to-use communication over the 2-wire serial interface.

IX. Digital Diagnostic Specifications

FTLX2072D327/FTLX2072D333 transceivers can be used in host systems that require either internally or externally calibrated digital diagnostics.

Parameter	Symbol	Min	Typ	Max	Units	Ref.
Accuracy						
Internally measured transceiver temperature	$\Delta DD_{\text{Temperature}}$		3		°C	
Internally measured transceiver supply voltage	$\Delta DD_{\text{Voltage}}$			3	%	
Measured TX bias current	ΔDD_{Bias}			10	%	1
Measured TX output power	$\Delta DD_{\text{Tx-Power}}$			2	dB	
Measured RX received average optical power	$\Delta DD_{\text{Rx-Power}}$			2	dB	
Dynamic Range for Rated Accuracy						
Internally measured transceiver temperature	$DD_{\text{Temperature}}$	-40		85	°C	
Internally measured transceiver supply voltage	DD_{Voltage}	3.1		3.5	V	
Measured TX bias current	DD_{Bias}	0		65	mA	
Measured TX output power	$DD_{\text{Tx-Power}}$	-8.2		+0.5	dBm	
Measured RX received average optical power	$DD_{\text{Rx-Power}}$	-14.4		+0.5	dBm	

Notes:

- Accuracy of measured Tx bias current is 10% of the actual bias current from the laser driver to the laser.

X. Mechanical Specifications

Finisar FTLX2072D327/FTLX2072D333 SFP+ transceivers are compatible with the SFF-8432 specification for improved pluggable form factor. Bail color for FTLX2072D327 is gray, bail color for FTLX2072D333 is green.

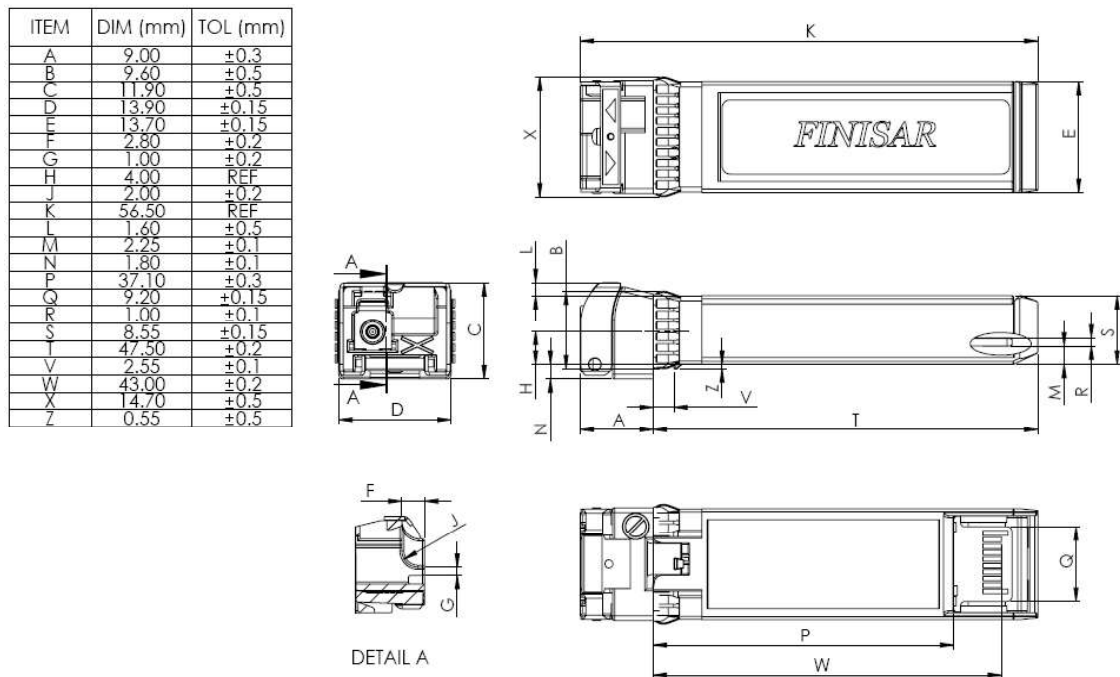
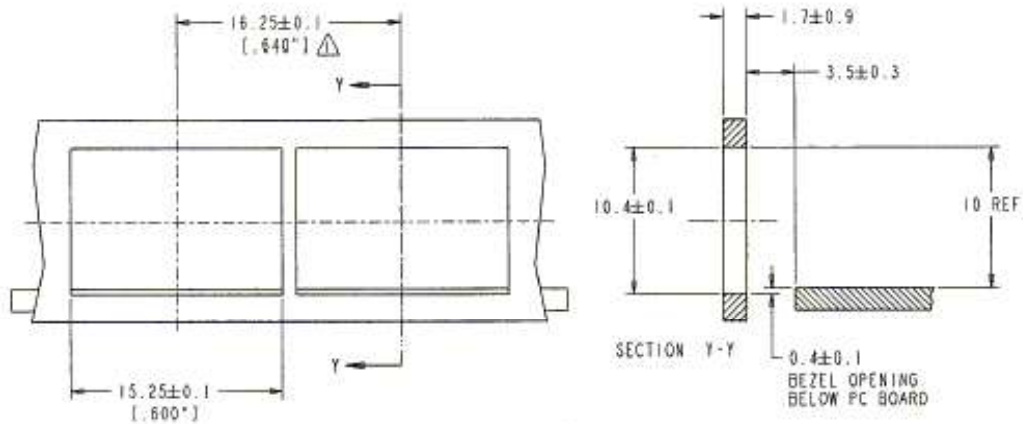
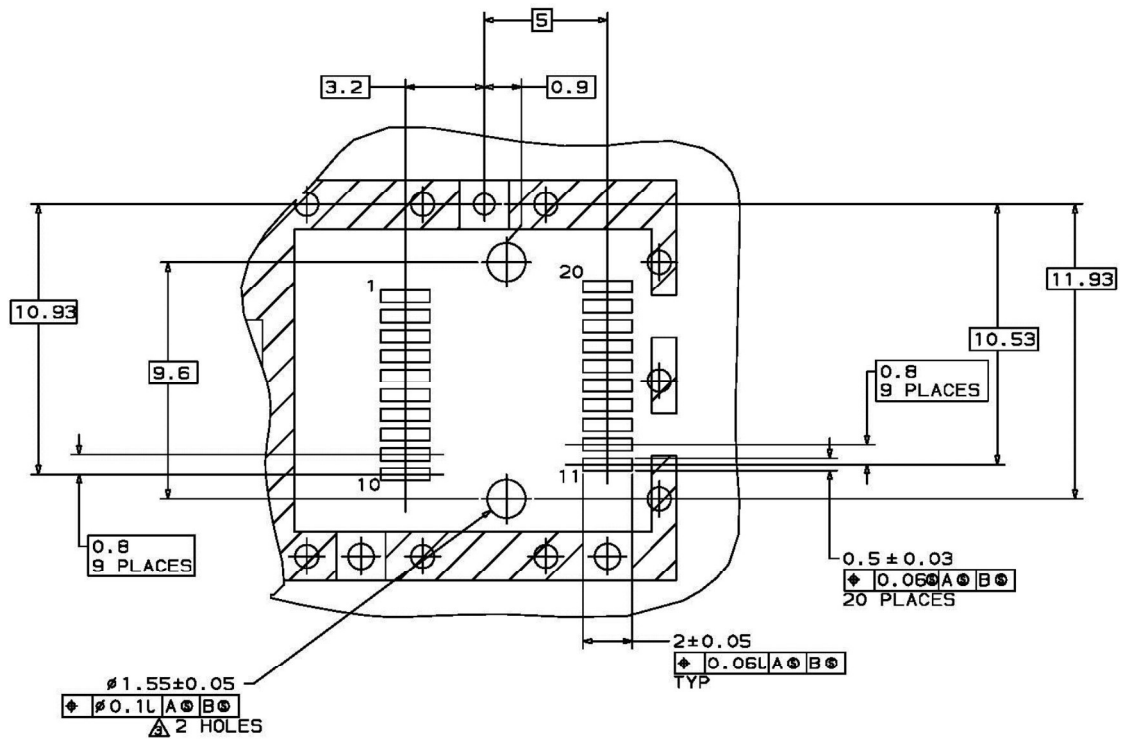

Figure 2. FTLX2072D327/FTLX2072D333 Mechanical Dimensions



- NOTES:
- 1. MINIMUM PITCH ILLUSTRATED. ENGLISH DIMENSIONS ARE FOR REFERENCE ONLY
 - 2. NOT RECOMMENDED FOR PCI EXPANSION CARD APPLICATIONS.

XII. Host - Transceiver Interface Block Diagram

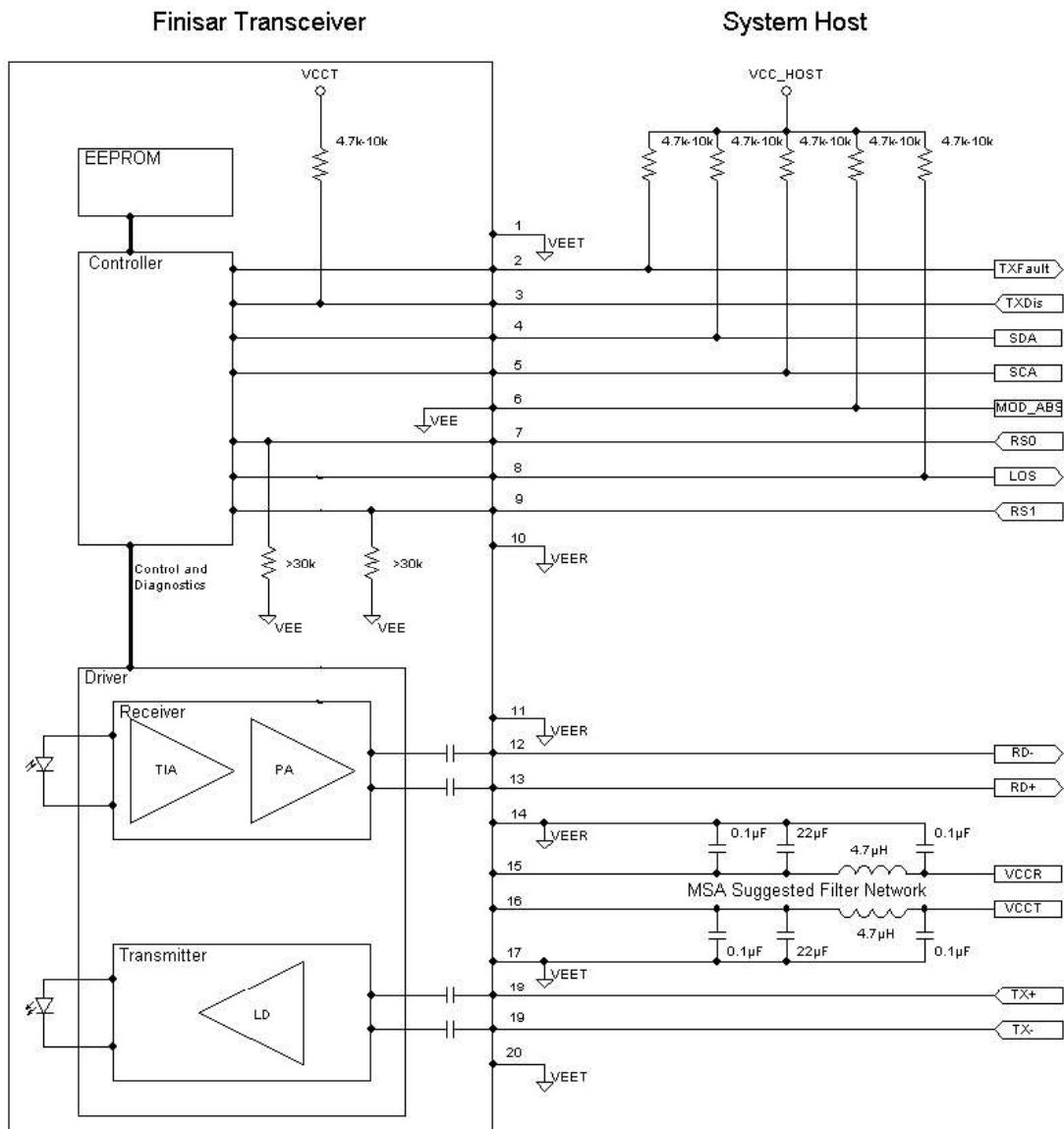

Figure 6-Host-Module Interface

XIII. References

1. “Specifications for Enhanced 8.5 and 10 Gigabit Small Form Factor Pluggable Module ‘SFP+ ‘”, SFF Document Number SFF-8431, Revision 4.1.
2. “Improved Pluggable Form factor”, SFF Document Number SFF-8432, Revision 4.2, April 18, 2007.
3. IEEE Std 802.3ae, Clause 52, PMD Type 10GBASE-LR. IEEE Standards Department.
4. American National Standard for Information Technology - Fibre Channel - 10 Gigabit Fibre Channel, Rev 3.5, April 9, 2003.
5. “Digital Diagnostics Monitoring Interface for Optical Transceivers”. SFF Document Number SFF-8472, Revision 11.3, Jun 11, 2013.
6. Directive 2011/65/EU of the European Council Parliament and of the Council, “on the restriction of the use of certain hazardous substances in electrical and electronic equipment”. Certain products may use one or more exemptions as allowed by the Directive.
7. “Application Note AN-2038: Finisar Implementation of RoHS Compliant Transceivers”.

XIV. For More Information

Finisar Corporation
1389 Moffett Park Drive
Sunnyvale, CA 94089-1133
Tel. 1-408-548-1000
Fax 1-408-541-6138
sales@finisar.com
www.finisar.com