

## Introduction to iXBlue Mach-Zehnder Modulators Bias Controllers

This application note aims to give intensity modulators users the basics to select and apply the proper RF and bias voltages to their device.

### Introduction :

Waveguide type LiNbO<sub>3</sub> Mach-Zehnder optical modulators offers multiple benefits for the modulation of light :

- high modulation speed capabilities (several x10 GHz)
- compactness
- reliability
- environmental robustness

They have been widely used in the telecom industry for nearly two decades (several x 100 000 LiNbO<sub>3</sub> intensity modulators are operating in the fiber optics networks all over the world), and they are also used in an increasing number of photonics applications such as :

- fiber optics sensors
- fiber lasers systems
- measurement equipment
- RF over fiber....

### Principle – Transfer function :

Waveguide LiNbO<sub>3</sub> Intensity modulators are Mach-Zehnder type interferometers: an input waveguide is split into two paths that are then recombined into an output waveguide. The two paths make up the two arms of the interferometer and the optical index modulation induced on each of them creates the intensity modulation at the output of the device.

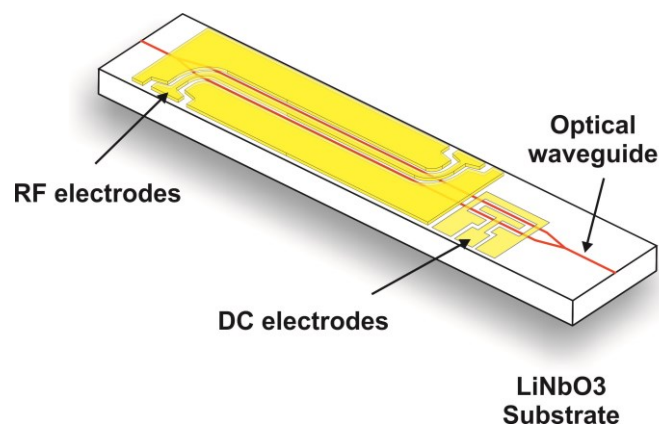

*Schematic view of a LiNbO<sub>3</sub> intensity modulator chip*



The optical index modulation is induced by an electric field into the electro-optic material, and the electrical field is obtained by applying a voltage between electrodes. There are generally two pairs of electrodes: modulation electrodes (often called RF electrodes) and DC electrodes (also called bias electrodes)

The transfer function of an intensity modulator driven by a time dependent voltage  $V(t)$  is :

$$I_{out}(t) = T_{mod} \frac{I_{in}}{2} \left[ 1 + \cos \left( \frac{\pi}{V_{\pi}} V(t) - \phi \right) \right]$$

with :

- $I_{out}$  : Output intensity
- $I_{in}$  : Input intensity
- $T_{mod}$  : optical transmission of the device
- $V_{\pi}$  : half-wave voltage of the modulator
- $\phi$  : phase term

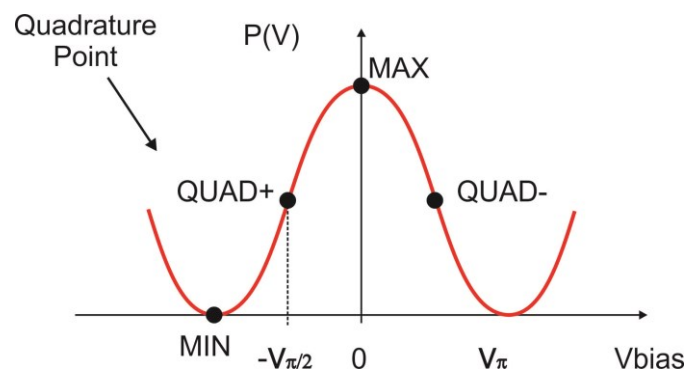

*Transfer function of a LiNbO<sub>3</sub> intensity Mach-Zehnder modulator*

## Theory and reality :

The intensity modulators are designed to have equal arms and thus balanced optical paths. In theory, the phase term  $\phi$  should be zero. However, there is always a small difference between the two optical paths due to material inhomogeneity, manufacturing tolerances... This imbalance explains the  $\phi$  phase term in the modulator function transfer.

In order to operate the intensity modulator and obtain the desired light modulation, one must apply two well suited electrical voltages to the modulator: a modulation voltage  $V(t)$  ( also called RF voltage) and a DC voltage (also called bias voltage).



## Operating point :

The modulator operating point is the point on the transfer curve around which the modulation signal is applied. It has to be selected depending on the targeted application. We can give the following examples:

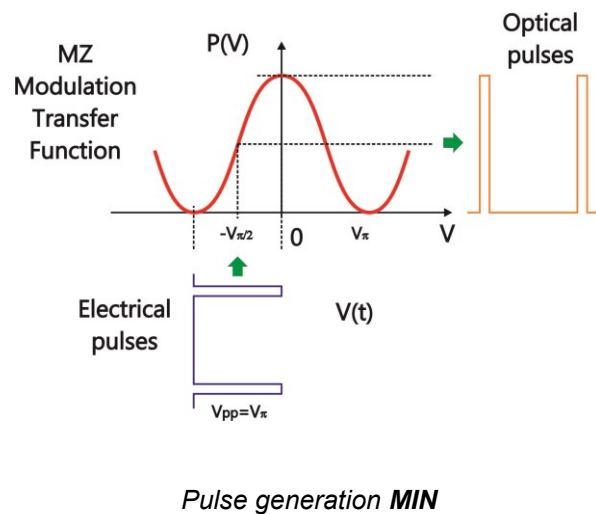
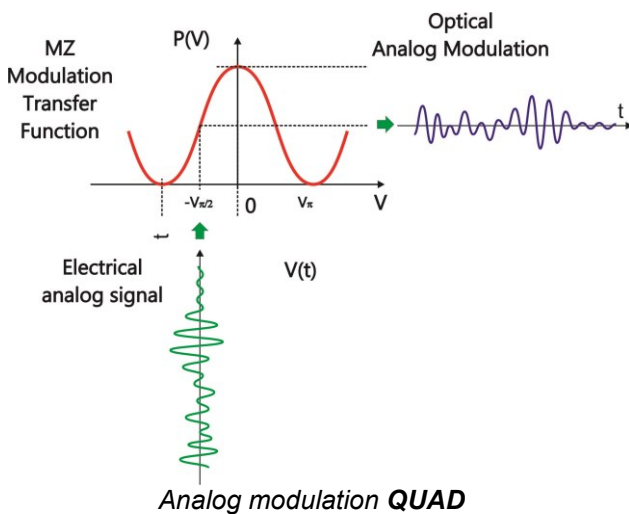
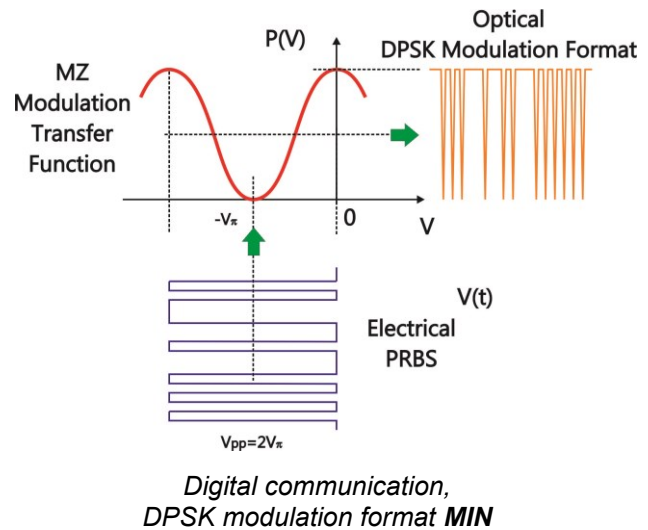
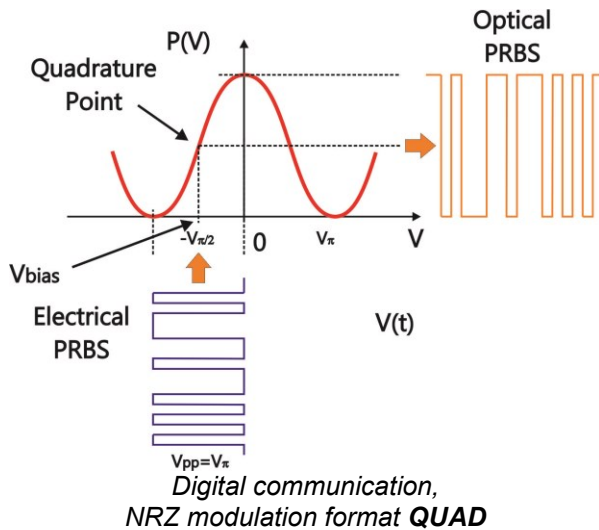

## Why bias voltage ?

As mentioned above, the Mach-Zehnder interferometer is not perfectly balanced. Moreover it is subject to drift caused by thermal changes, thermal inhomogeneity, aging, photo refractive effects, static electrical charge accumulation... This drift causes the transfer function to move in the horizontal direction ; the modulation signal is then applied to a changing operating point, that can modify strongly the obtained modulation.

The bias voltage applied to the DC electrodes aims to :

- selecting the desired operating point of the modulator
- compensating for the possible modulator drift and locking the device operating point so as to keep stable operation conditions

The bias voltage can be supplied by a simple voltage source and manually adjusted so as the desired operating point is reached. In such conditions, the voltage will have to be readjusted manually in case of drift of the modulator. This may be workable in laboratory with low drift modulators and stable environmental conditions

**However, for a long term operation and especially in all systems having to operate over changing temperature conditions, an automatic bias control circuit is necessary so as to permanently supply the right DC voltage and to lock the selected operating point.**

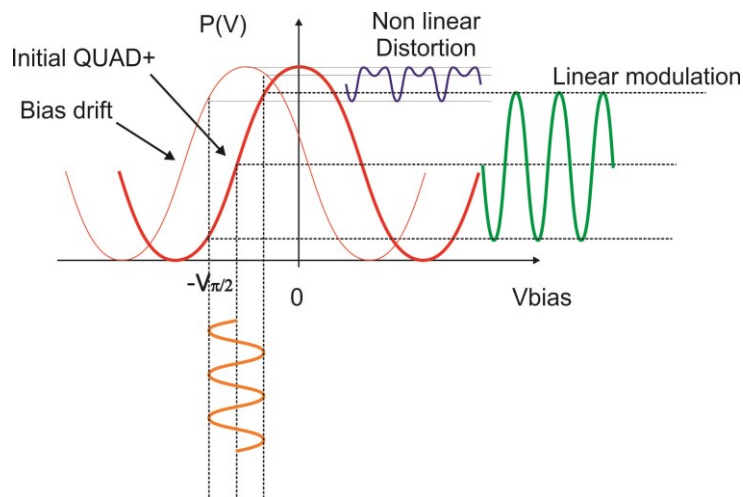

*A drift of the modulator transfer function results in a change of the optical modulated signal if the bias voltage is not adjusted accordingly. In the example above, the curve has drifted and the optical modulated signal is seriously affected in both amplitude and frequency if the bias voltage is not corrected.*

iXBlue offers a choice of MBC (Modulator Bias controller) solutions : bench-top instrument MBC-DG-BT, board MBC-DG-board that can lock the operating point of Mach-Zehnder modulators for most of the applications.



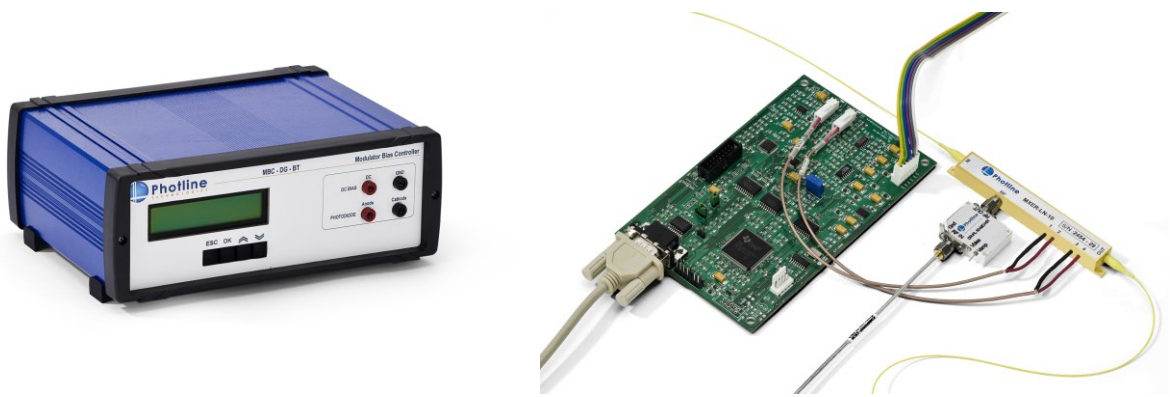

Left : MBC-DG-BT bench top bias controller  
 Right : MBC-DG-board OEM bias control board

## Modulation Signal :

Once the operating point is selected, and the proper bias voltage applied, one can apply the modulation signal to the modulation electrodes.

Here again, the peak-to-peak amplitude of the modulation signal has to be chosen depending on the targeted application. Examples:

Digital communication, NRZ modulation format	$V_{\pi}$
Digital communication, DPSK modulation format	$2 \times V_{\pi}$
Analog modulation	$< V_{\pi}$
Pulse generation	$V_{\pi}$

The typical  $V_{\pi}$  for an intensity modulator is 5 V. It is often higher than the peak-to-peak voltage delivered by RF generators or telecom multiplexers. As a consequence, it is often necessary to amplify the electrical signals so as to get modulation signals compatible with the modulators specifications ( $V_{\pi}$ ). This is achieved by amplifier modules, often called modulator drivers.

iXBlue offers a choice of modulator drivers that cover most of the applications : analog, digital, pulse modulation regimes, single or double  $V_{\pi}$  modulation, 10 GHz/ 10 Gb/s up to 40 GHz/ 40 Gb/s



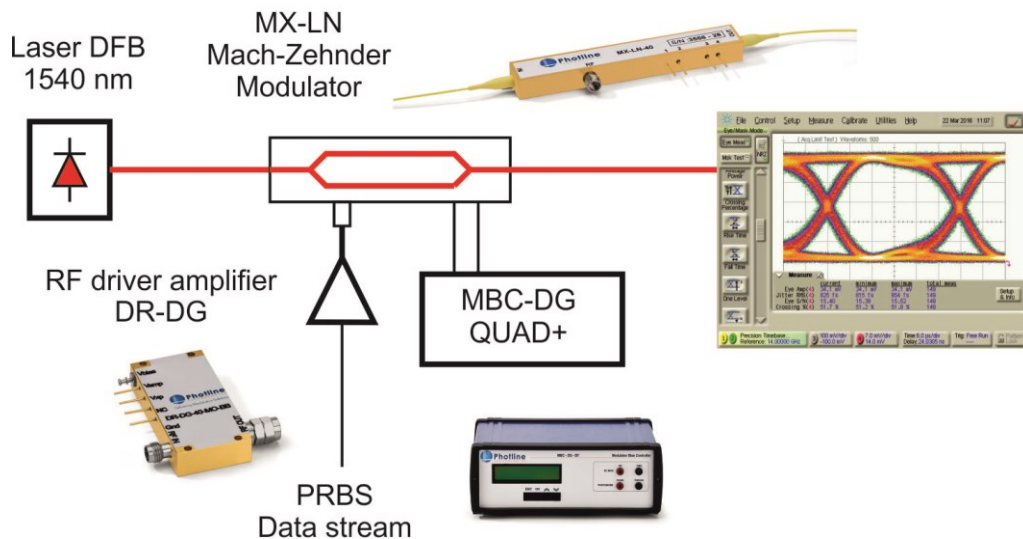

*Typical set-up for digital NRZ modulation*

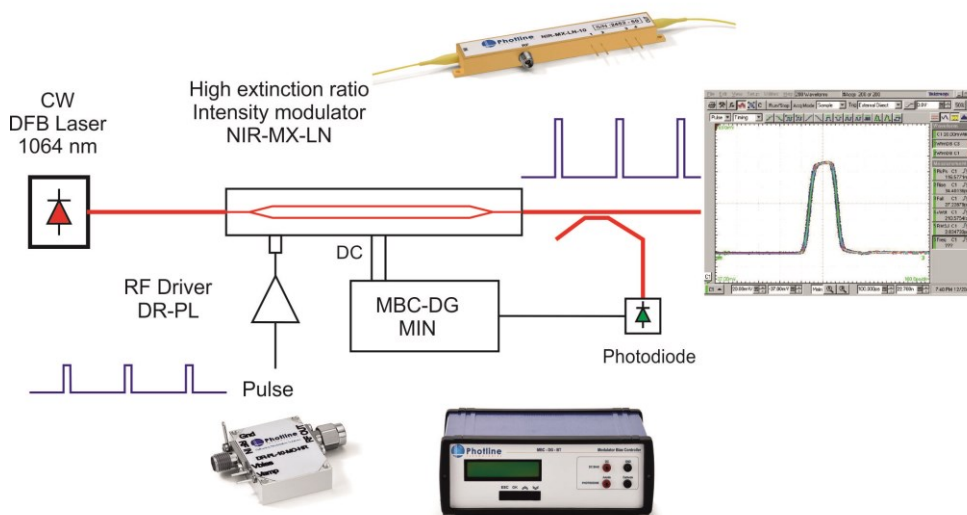

*Typical set-up for pulse modulation*

